

SERVICE MANUAL

STEREO CONTROL AMPLIFIER

SANSUI C-2301



●規格

入力感度/入力インピーダンス(1,000Hz)

PHONO-1, 2(MC TRANS-LOW).....	70 μ V/3 Ω
PHONO-1, 2(MC TRANS-HIGH).....	200 μ V/30 Ω
PHONO-1, 2(HIGH MC).....	2mV/100 Ω
PHONO-1, 2(MM).....	2mV/47k Ω
CD, TUNER, LINE-1, 2.....	150mV/47k Ω
TAPE PLAY-1, 2, 3.....	150mV/47k Ω
ADAPTOR RETURN.....	150mV/47k Ω

最大許容入力(1,000Hz 全高調波歪率: 0.01%)

PHONO-1, 2(MC HIGH).....	40mV
PHONO-1, 2(MM).....	350mV

出力電圧/出力インピーダンス(1,000Hz)

TAPE REC-1, 2, 3.....	150mV/100 Ω 以下
OUTPUT-1, 2.....	1.2V/100 Ω 以下

最大出力(1,000Hz 全高調波歪率0.01%)

OUTPUT-1, 2.....	20V
------------------	-----

全高調波歪率(20Hz~20kHz)

PHONO-1, 2(MM).....	0.005%以下
CD, TUNER, LINE-1, 2.....	0.003%以下
TAPE PLAY-1, 2, 3.....	0.003%以下
ADAPTOR RETURN.....	0.003%以下

混交調歪率(60Hz: 7,000Hz=4:1, SMPTE法)

PHONO-1, 2(MM).....	0.005%以下
CD, TUNER, LINE-1, 2.....	0.003%以下
TAPE PLAY-1, 2, 3.....	0.003%以下
ADAPTOR RETURN.....	0.003%以下

周波数特性

PHONO-1, 2(MM)	(RIAA偏差).....	10Hz~300kHz \pm 0.2dB
CD, TUNER, LINE-1, 2.....		DC~500kHz \pm 3dB
TAPE PLAY-1, 2, 3.....		DC~500kHz \pm 3dB
ADAPTOR RETURN.....		DC~500kHz \pm 3dB

SN比(Aネットワーク, ショートサーキット)

PHONO-1, 2(MC).....	80dB以上
PHONO-1, 2(MM).....	90dB以上
CD, TUNER, LINE-1, 2.....	110dB以上
TAPE PLAY-1, 2, 3.....	110dB以上
ADAPTOR RETURN.....	110dB以上

サブソニックフィルター.....16Hz(-3dB) 6dB/oct.

ミュートング..... ∞

電源電圧.....100V

電源周波数.....50Hz/60Hz

定格消費電力(電気用品取締法).....60W

寸法.....幅474mm X 高さ160mm X 奥行422mm

重量.....20.9kg(本体のみ)

付属品

ピンプラグコード.....2本

ショートピンプラグ.....12個

※改良のため、予告なく意匠、仕様の一部を変更することがあります。



SANSUI ELECTRIC CO., LTD.

1. ブロックダイアグラム

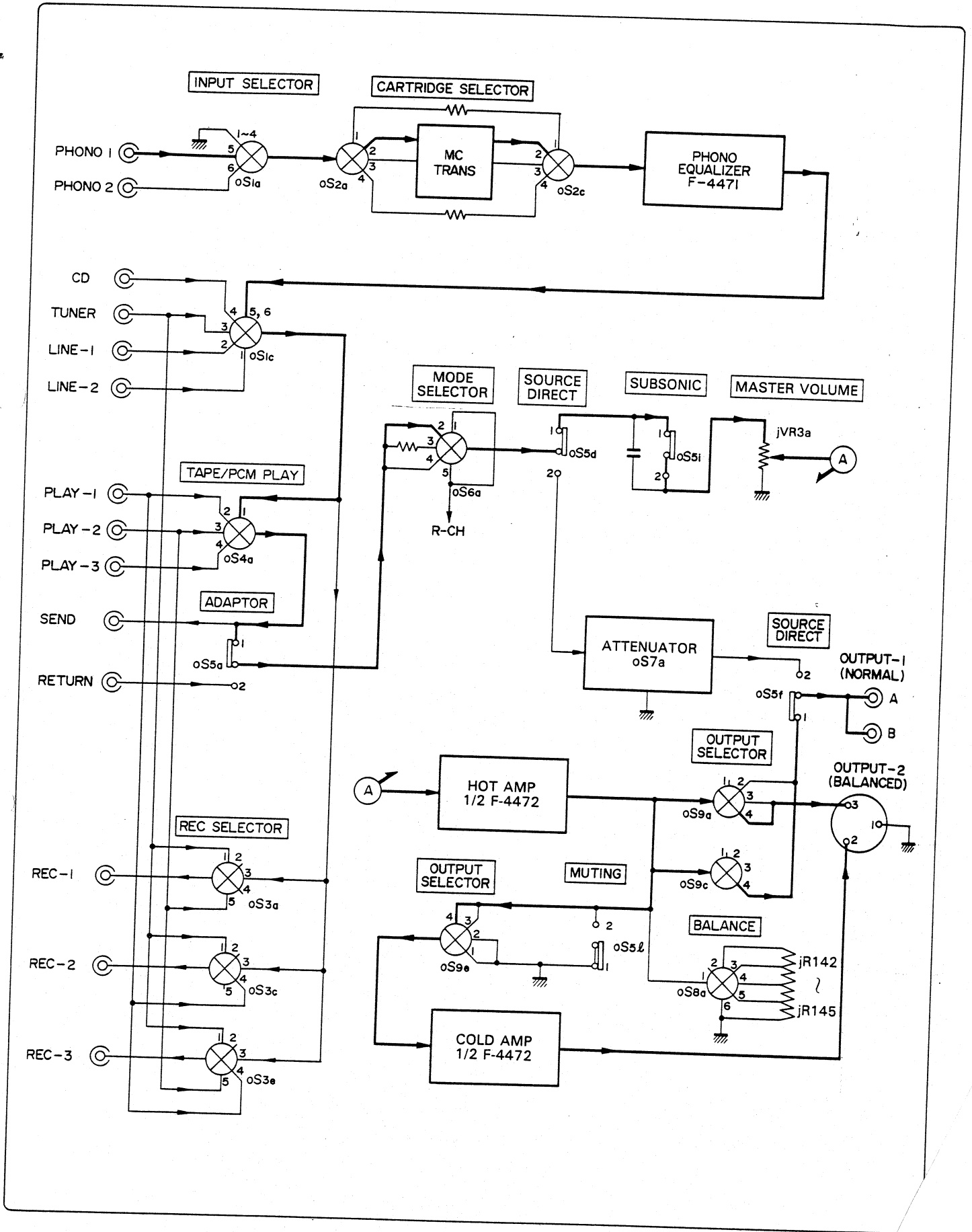

2. プリント基板の部品配置図と部品表

2-1. F-4470電源回路基板(ストック番号 00723600)

シルク側

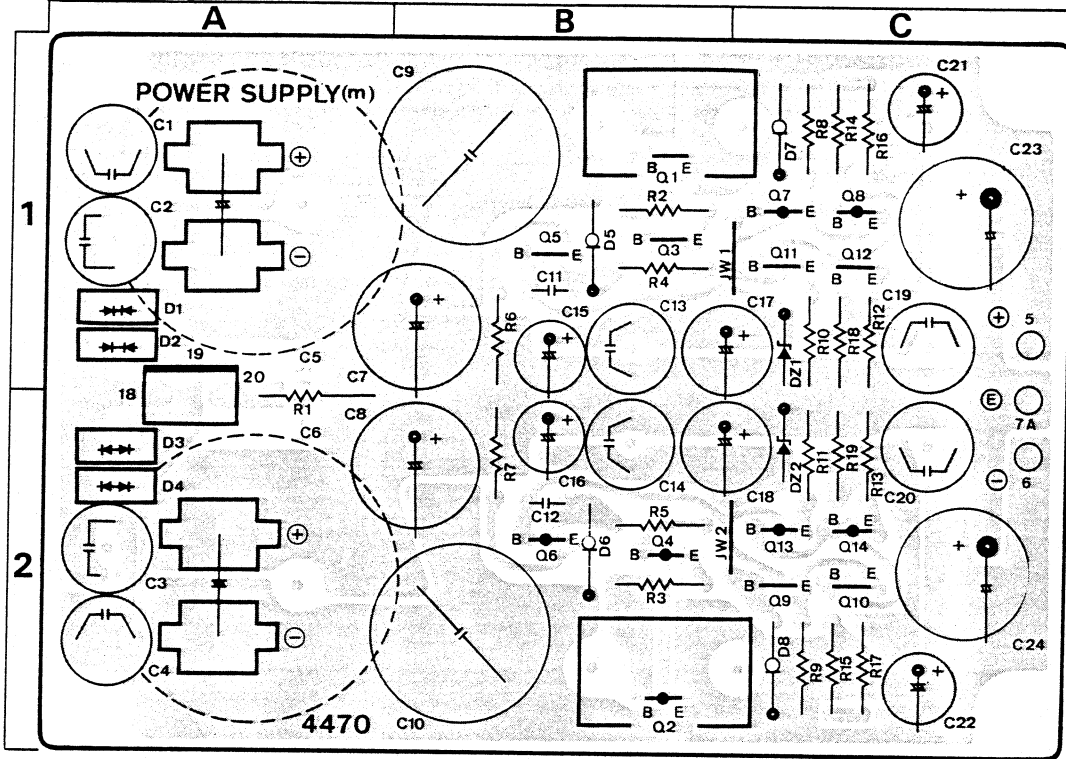

部品表

Parts No.	Stock No.	Description
•Transistor		
△ mQ1	46728901	2SC3298
△ mQ2	46728801	2SA1306
mQ3	03067401	2SC1845
mQ4	03010901	2SA992
mQ5	03067401	2SC1845
mQ6	03010901	2SA992
mQ7	03010901	2SA992
mQ8	03010901	2SA992
mQ9	03067401	2SC1845
mQ10	03067401	2SC1845
mQ11	03067401	2SC1845
mQ12	03067401	2SC1845
mQ13	03010901	2SA992
mQ14	03010901	2SA992
•Diode		
△ mD1	46639400	C10P20F-N
△ mD2	46639400	C10P20F-N
△ mD3	46639500	C10P20F-R
△ mD4	46639500	C10P20F-R
mD5	46445300	10YD2.4 (Constant Current)
mD6	46445300	10YD2.4 (Constant Current)
mD7	46445300	10YD2.4 (Constant Current)
mD8	46445300	10YD2.4 (Constant Current)
•Zener Diode		
mDZ1	46807500	RD24E-B3
mDZ2	46807500	RD24E-B3
mR1	46565700	10Ω 1/2W C.R.
mR2	46017800	2.2kΩ 1/2W C.R.
mR3	46017800	2.2kΩ 1/2W C.R.
mR4	46015400	220Ω 1/2W C.R.
mR5	46015400	220Ω 1/2W C.R.
mR6	46016400	560Ω 1/2W C.R.
mR7	46016400	560Ω 1/2W C.R.
mR8	46020000	18kΩ 1/2W C.R.

Parts No.	Stock No.	Description
mR9	46020000	18kΩ 1/2W C.R.
mR10	46016400	560Ω 1/2W C.R.
mR11	46016400	560Ω 1/2W C.R.
mR12	46016400	560Ω 1/2W C.R.
mR13	46016400	560Ω 1/2W C.R.
mR14	46019800	15kΩ 1/2W C.R.
mR15	46019800	15kΩ 1/2W C.R.
mR16	46017400	1.5kΩ 1/2W C.R.
mR17	46017400	1.5kΩ 1/2W C.R.
mR18	46020000	18kΩ 1/2W C.R.
mR19	46020000	18kΩ 1/2W C.R.
mC1	46447000	4700pF 400V P.C.
mC2	46447000	4700pF 400V P.C.
mC3	46447000	4700pF 400V P.C.
mC4	46447000	4700pF 400V P.C.
mC5	46946300	2200μF 80V E.C.
mC6	46946300	2200μF 80V E.C.
mC7	46629700	100μF 100V E.C.
mC8	46629700	100μF 100V E.C.
mC9	46506700	0.82μF 100V F.C.
mC10	46506700	0.82μF 100V F.C.
mC13	46420400	0.01μF 125V P.C.
mC14	46420400	0.01μF 125V P.C.
mC15	46627900	47μF 50V E.C.
mC16	46627900	47μF 50V E.C.
mC17	46628100	100μF 50V E.C.
mC18	46628100	100μF 50V E.C.
mC19	46420400	0.01μF 125V P.C.
mC20	46420400	0.01μF 125V P.C.
mC21	46627900	47μF 50V E.C.
mC22	46627900	47μF 50V E.C.
mC23	46540300	470μF 50V E.C.
mC24	46540300	470μF 50V E.C.
mC30	46420400	0.01μF 125V P.C.
mC31	46420400	0.01μF 125V P.C.
mC34	46447000	4700pF 400V P.C.

2-2. F-4471イコライザーアンプ基板(ストック番号 00723700)

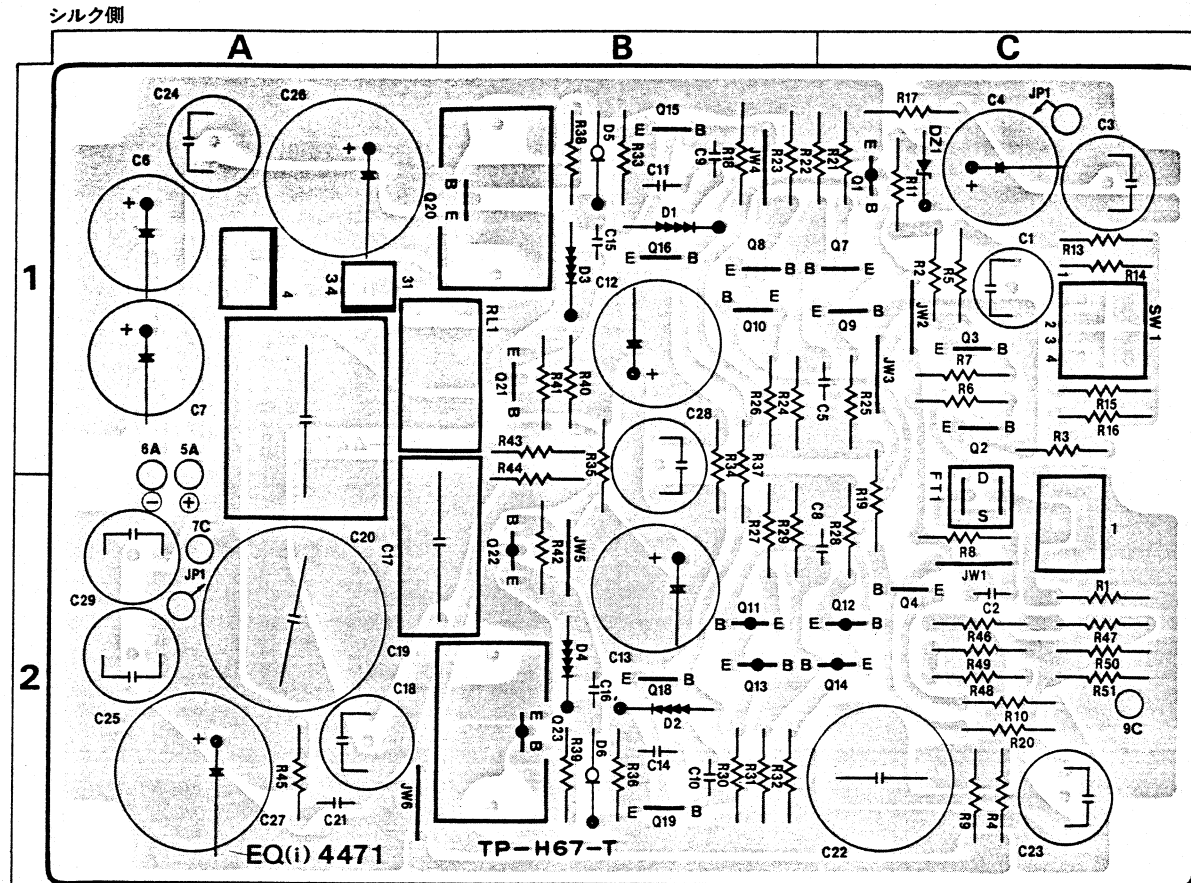

部品表

Parts No.	Stock No.	Description
•Transistor		
iQ1	03010901	2SA992
iQ2	03067401	2SC1845
iQ3	03067401	2SC1845
iQ4	03067401	2SC1845
iQ7	03067401	2SC1845
iQ8	03067401	2SC1845
iQ9	03067401	2SC1845
iQ10	03067401	2SC1845
iQ11	03010901	2SA992
iQ12	03010901	2SA992
iQ13	03010901	2SA992
iQ14	03010901	2SA992
iQ15	03007901	2SA899
iQ16	03007901	2SA899
iQ18	03064001	2SC1904
iQ19	03064001	2SC1904
△iQ20	46728901	2SC3298
△iQ21	46728901	2SC3298
△iQ22	46728801	2SA1306
△iQ23	46728801	2SA1306
•FET		
iFT1	03703500	2SK146
•Diode		
iD1	03402000	SV04 Varistor
iD2	03402000	SV04 Varistor
iD3	03402000	SV04 Varistor
iD4	03402000	SV04 Varistor
iD5	46445600	10YD4.5 (Constant Current)
iD6	46445600	10YD4.5 (Constant Current)
•Zener Diode		
iDZ1	46808000	RD27E-B4
iR1	46575300	100kΩ 1/2W C.R.

Parts No.	Stock No.	Description
iR2	46571300	2.2kΩ 1/2W C.R.
iR3	46571300	2.2kΩ 1/2W C.R.
iR4	46568100	100Ω 1/2W C.R.
iR5	46567700	68Ω 1/2W C.R.
iR6	46568100	100Ω 1/2W C.R.
iR7	46568100	100Ω 1/2W C.R.
iR8	46573100	12kΩ 1/2W C.R.
iR9	46568100	100Ω 1/2W C.R.
iR10	46571300	2.2kΩ 1/2W C.R.
iR11	46567800	75Ω 1/2W C.R.
iR12	46021000	47kΩ 1/2W C.R.
iR13	46565700	10Ω 1/2W C.R.
iR14	46566500	22Ω 1/2W C.R.
iR15	46567100	39Ω 1/2W C.R.
iR16	46567900	82Ω 1/2W C.R.
iR17	46017200	1.2kΩ 1/2W C.R.
iR18	46572300	5.6kΩ 1/2W C.R.
iR19	46572700	8.2kΩ 1/2W C.R.
iR20	46572100	4.7kΩ 1/2W C.R.
iR21	46016800	820Ω 1/2W C.R.
iR22	46573700	22kΩ 1/2W C.R.
iR23	46016800	820Ω 1/2W C.R.
iR24	46573700	22kΩ 1/2W C.R.
iR25	46568900	220Ω 1/2W C.R.
iR26	46568900	220Ω 1/2W C.R.
iR27	46568900	220Ω 1/2W C.R.
iR28	46568900	220Ω 1/2W C.R.
iR29	46574700	56kΩ 1/2W C.R.
iR30	46016800	820Ω 1/2W C.R.
iR31	46574700	56kΩ 1/2W C.R.
iR32	46016800	820Ω 1/2W C.R.
iR33	46568300	120Ω 1/2W C.R.
iR34	46569900	560Ω 1/2W C.R.
iR35	46569900	560Ω 1/2W C.R.
iR36	46568300	120Ω 1/2W C.R.
iR37	46575100	82kΩ 1/2W C.R.

部品表<F-4471>

Parts No.	Stock No.	Description
iR38	46568100	100Ω 1/2W C.R.
iR39	46568100	100Ω 1/2W C.R.
iR40	46567100	39Ω 1/2W C.R.
iR41	46566500	22Ω 1/2W C.R.
iR42	46566500	22Ω 1/2W C.R.
iR43	46568100	100Ω 1/2W C.R.
iR44	46568100	100Ω 1/2W C.R.
iR45	46567300	47Ω 1/2W C.R.
iR46	46574100	33kΩ 1/2W C.R.
iR47	46571700	3.3kΩ 1/2W C.R.
iR48	46571500	2.7kΩ 1/2W C.R.
iR49	46568100	100Ω 1/2W C.R.
iR50	46568100	100Ω 1/2W C.R.
iR51	46568100	100Ω 1/2W C.R.
iR52	46576900	470kΩ 1/2W C.R.
IC1	46420000	4700pF 125V P.C.
IC2	46419700	2700pF 125V P.C.
IC3	46420400	0.01μF 125V P.C.
IC4	46628500	470μF 50V E.C.
IC5	46419700	2700pF 125V P.C.
IC6	46628500	470μF 50V E.C.
IC7	46628500	470μF 50V E.C.
IC8	46419700	2700pF 125V P.C.

Parts No.	Stock No.	Description
IC11	46419700	2700pF 125V P.C.
IC12	46540300	470μF 50V E.C.
IC13	46540300	470μF 50V E.C.
IC14	46419700	2700pF 125V P.C.
IC15	46419700	2700pF 125V P.C.
IC16	46419700	2700pF 125V P.C.
IC17	46615300	0.12μF 50V P.C.
IC18	46420400	0.01μF 125V P.C.
IC19	46506700	0.82μF 100V F.C.
IC20	48063000	6.8μF 100V P.C.
IC22	48062900	81000pF 50V P.C.
IC23	48062800	29000pF 50V P.C.
IC24	46420400	0.01μF 125V P.C.
IC25	46420400	0.01μF 125V P.C.
IC26	48004400	1000μF 50V E.C.
IC27	48004400	1000μF 50V E.C.
IC28	46420400	0.01μF 125V P.C.
IC29	46420400	0.01μF 125V P.C.
iSW1	48063100	Dip SW., DC 0V Adj.
IRL1	48004500	Relay, Protector

2-3. F-4474プロテクター回路基板

シルク側

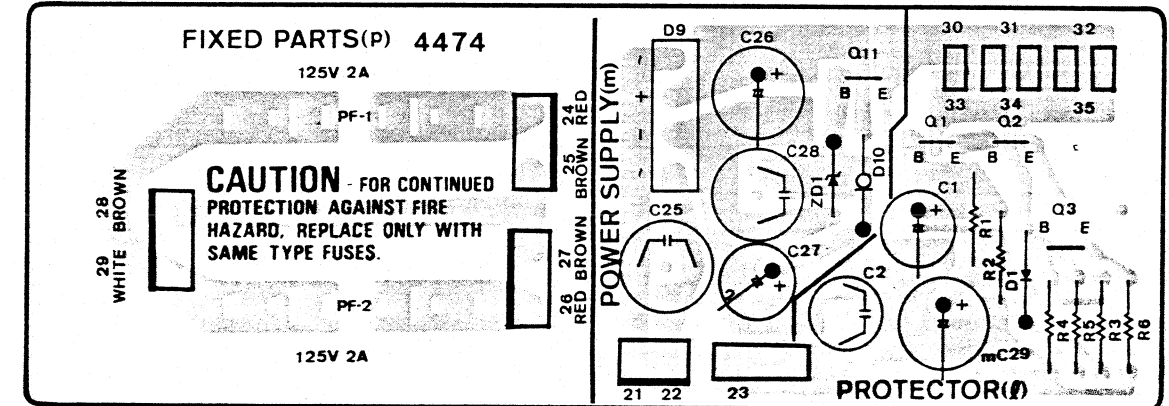

部品表

Parts No.	Stock No.	Description
•Transistor		
iQ1	03068301	2SC2320
iQ2	03068301	2SC2320
iQ3	03068301	2SC2320
•Diode		
iD1	03117700	10E-2
iR1	46021200	56kΩ 1/2W C.R.
iR2	46019400	10kΩ 1/2W C.R.
iR3	46019200	8.2kΩ 1/2W C.R.
iR4	46018400	3.9kΩ 1/2W C.R.
iR5	46016600	680Ω 1/2W C.R.
iR6	46012600	15Ω 1/2W C.R.
IC2	46420400	0.01μF 125V P.C.
•Transistor		
△mQ15	46728901	2SC3298

Parts No.	Stock No.	Description
•Diode		
△mD9	07193300	UB-152LFF
mD10	46445300	10YD2.4 (Constant Current)
•Zener Diode		
mDZ3	46808000	RD27E-B4
mC25	46447000	4700pF 400V P.C.
mC26	46628100	100μF 50V E.C.
mC27	46627900	47μF 50V E.C.
mC28	46420400	0.01μF 125V P.C.
mC29	46628100	100μF 50V E.C.
△pF1	46504400	2A Fuse
△pF2	46504400	2A Fuse

2-4. F-4472出力アンプ回路基板(ストック番号 00723800)

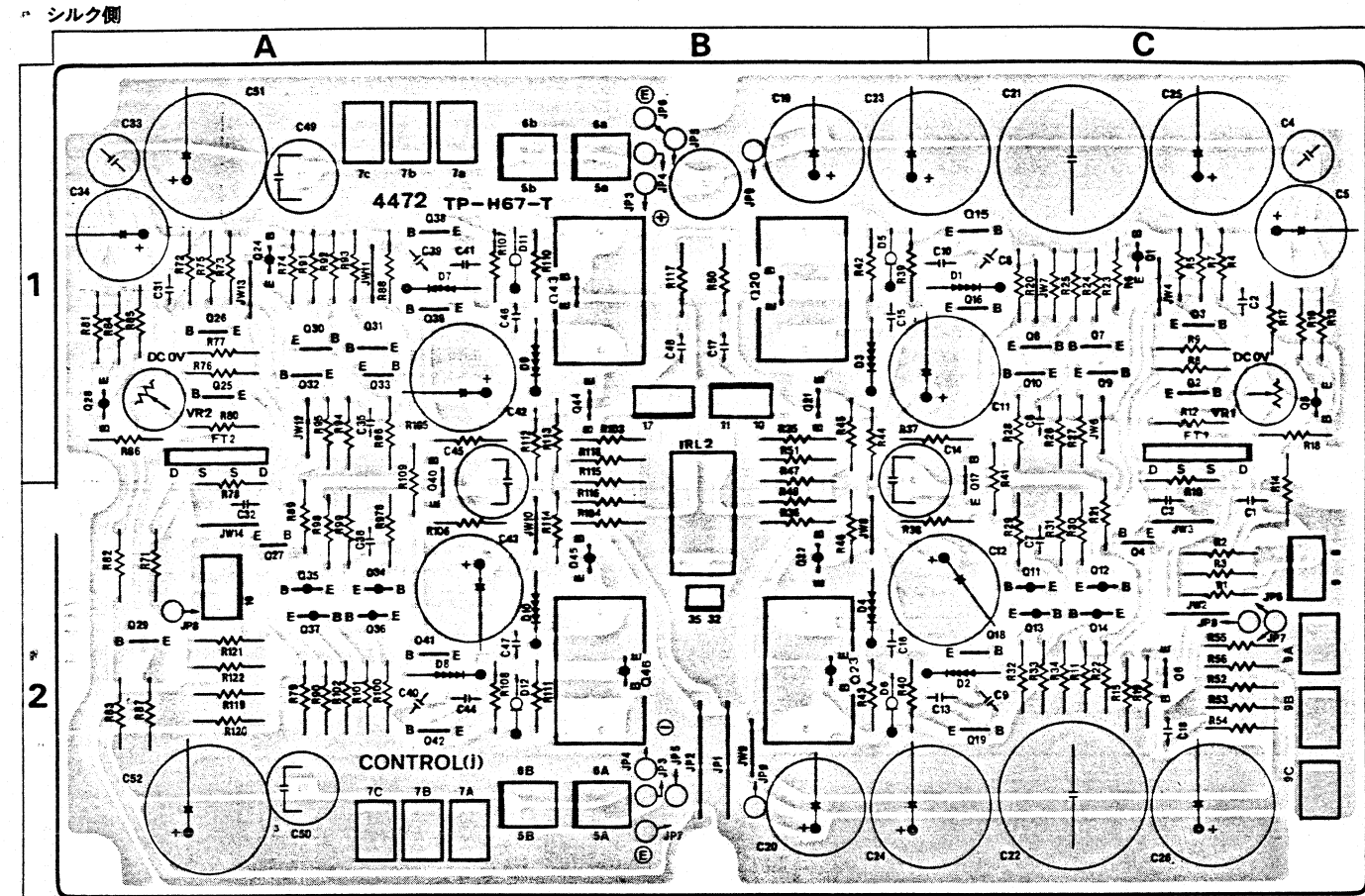

部品表

Parts No.	Stock No.	Description
• Transistor		
jQ1	03010901	2SA992
jQ2	03067401	2SC1845
jQ3	03067401	2SC1845
jQ4	03067401	2SC1845
jQ5	03010901	2SA992
jQ6	03067401	2SC1845
jQ7	03067401	2SC1845
jQ8	03067401	2SC1845
jQ9	03067401	2SC1845
jQ10	03067401	2SC1845
jQ11	03010901	2SA992
jQ12	03010901	2SA992
jQ13	03010901	2SA992
jQ14	03010901	2SA992
jQ15	03007901	2SA899
jQ16	03007901	2SA899
jQ17	03067401	2SC1845
jQ18	03064001	2SC1904
jQ19	03064001	2SC1904
jQ20	46728901	2SC3298
jQ21	46728901	2SC3298
jQ22	46728801	2SA1306
jQ23	46728801	2SA1306
jQ24	03010901	2SA992
jQ25	03067401	2SC1845
jQ26	03067401	2SC1845
jQ27	03067401	2SC1845
jQ28	03010901	2SA992
jQ29	03067401	2SC1845
jQ30	03067401	2SC1845
jQ31	03067401	2SC1845
jQ32	03067401	2SC1845
jQ33	03067401	2SC1845

Parts No.	Stock No.	Description
jQ34	03010901	2SA992
jQ35	03010901	2SA992
jQ36	03010901	2SA992
jQ37	03010901	2SA992
jQ38	03007901	2SA899
jQ39	03007901	2SA899
jQ40	03067401	2SC1845
jQ41	03064001	2SC1904
jQ42	03064001	2SC1904
△ jQ43	46728901	2SC3298
△ jQ44	46728901	2SC3298
△ jQ45	46728801	2SA1306
△ jQ46	46728801	2SA1306
• FET		
jFT1	07110000	μPA68H-L
	or 07110001	μPA68H-M
jFT2	07110000	μPA68H-L
	or 07110001	μPA68H-M
jD1	03402000	SV04 Varistor
jD2	03402000	SV04 Varistor
jD3	03402000	SV04 Varistor
jD4	03402000	SV04 Varistor
jD5	46445600	10YD4.5 (Constant Current)
jD6	46445600	10YD4.5 (Constant Current)
jD7	03402000	SV04 Varistor
jD8	03402000	SV04 Varistor
jD9	03402000	SV04 Varistor
jD10	03402000	SV04 Varistor
jD11	46445600	10YD4.5 (Constant Current)
jD12	46445600	10YD4.5 (Constant Current)
jR1	46575900	180kΩ 1/2W C.R.

部品表(F-4472)

Parts No.	Stock No.	Description
jR2	46568900	220Ω 1/2W C.R.
jR3	46569100	270Ω 1/2W C.R.
jR4	46572900	10kΩ 1/2W C.R.
jR5	46572900	10kΩ 1/2W C.R.
jR6	46021000	47kΩ 1/2W C.R.
jR7	46569700	470Ω 1/2W C.R.
jR8	46568100	100Ω 1/2W C.R.
jR9	46568100	100Ω 1/2W C.R.
jR10	46020000	18kΩ 1/2W C.R.
jR11	46018200	3.3kΩ 1/2W C.R.
jR12	46571100	2.8kΩ 1/2W C.R.
jR13	46020200	22kΩ 1/2W C.R.
jR14	46021000	47kΩ 1/2W C.R.
jR15	46020200	22kΩ 1/2W C.R.
jR16	46020200	22kΩ 1/2W C.R.
jR17	46569300	330Ω 1/2W C.R.
jR18	46569300	330Ω 1/2W C.R.
jR19	46020200	22kΩ 1/2W C.R.
jR20	46018800	5.6kΩ 1/2W C.R.
jR21	46019200	8.2kΩ 1/2W C.R.
jR22	46018600	4.7kΩ 1/2W C.R.
jR23	46018000	2.7kΩ 1/2W C.R.
jR24	46020200	22kΩ 1/2W C.R.
jR25	46018000	2.7kΩ 1/2W C.R.
jR26	46020200	22kΩ 1/2W C.R.
jR27	46017000	1kΩ 1/2W C.R.
jR28	46017000	1kΩ 1/2W C.R.
jR29	46017000	1kΩ 1/2W C.R.
jR30	46017000	1kΩ 1/2W C.R.
jR31	46021200	56kΩ 1/2W C.R.
jR32	46018000	2.7kΩ 1/2W C.R.
jR33	46021200	56kΩ 1/2W C.R.
jR34	46018000	2.7kΩ 1/2W C.R.
jR35	46574700	56kΩ 1/2W C.R.
jR36	46574700	56kΩ 1/2W C.R.
jR37	46018000	2.7kΩ 1/2W C.R.
jR38	46017000	1kΩ 1/2W C.R.
jR39	46570500	1kΩ 1/2W C.R.
jR40	46570500	1kΩ 1/2W C.R.
jR41	46021600	82kΩ 1/2W C.R.
jR42	46568100	100Ω 1/2W C.R.
jR43	46568100	100Ω 1/2W C.R.
jR44	46568300	120Ω 1/2W C.R.
jR45	46566900	33Ω 1/2W C.R.
jR46	46566900	33Ω 1/2W C.R.
jR48	46568100	100Ω 1/2W C.R.
jR50	46568300	120Ω 1/2W C.R.
jR51	46575300	100kΩ 1/2W C.R.
jR52	46572100	4.7kΩ 1/2W C.R.
jR53	46572100	4.7kΩ 1/2W C.R.
jR54	46570300	820Ω 1/2W C.R.
jR55	46570300	820Ω 1/2W C.R.
jR56	46570300	820Ω 1/2W C.R.
jR71	46568100	100Ω 1/2W C.R.
jR72	46019400	10kΩ 1/2W C.R.
jR73	46019400	10kΩ 1/2W C.R.
jR74	46021000	47kΩ 1/2W C.R.
jR75	46016600	680Ω 1/2W C.R.
jR76	46568100	100Ω 1/2W C.R.
jR77	46568100	100Ω 1/2W C.R.
jR78	46020000	18kΩ 1/2W C.R.
jR79	46018200	3.3kΩ 1/2W C.R.
jR80	46570900	1.5kΩ 1/2W C.R.
jR81	46020200	22kΩ 1/2W C.R.
jR82	46021000	47kΩ 1/2W C.R.
jR83	46020200	22kΩ 1/2W C.R.
jR84	46020200	22kΩ 1/2W C.R.
jR85	46015800	330Ω 1/2W C.R.
jR86	46015800	330Ω 1/2W C.R.
jR87	46020200	22kΩ 1/2W C.R.
jR88	46018800	5.6kΩ 1/2W C.R.
jR89	46019200	8.2kΩ 1/2W C.R.
jR90	46018600	4.7kΩ 1/2W C.R.
jR91	46018000	2.7kΩ 1/2W C.R.

Parts No.	Stock No.	Description
jR92	46020200	22kΩ 1/2W C.R.
jR93	46018000	2.7kΩ 1/2W C.R.
jR94	46020200	22kΩ 1/2W C.R.
jR95	46017000	1kΩ 1/2W C.R.
jR96	46017000	1kΩ 1/2W C.R.
jR97	46017000	1kΩ 1/2W C.R.
jR98	46017000	1kΩ 1/2W C.R.
jR99	46021200	56kΩ 1/2W C.R.
jR100	46018000	2.7kΩ 1/2W C.R.
jR101	46021200	56kΩ 1/2W C.R.
jR102	46018000	2.7kΩ 1/2W C.R.
jR103	46574300	39kΩ 1/2W C.R.
jR104	46574300	39kΩ 1/2W C.R.
jR105	46018000	2.7kΩ 1/2W C.R.
jR106	46017000	1kΩ 1/2W C.R.
jR107	46017000	1kΩ 1/2W C.R.
jR108	46017000	1kΩ 1/2W C.R.
jR109	46021600	82kΩ 1/2W C.R.
jR110	46014600	100Ω 1/2W C.R.
jR111	46014600	100Ω 1/2W C.R.
jR112	46014800	120Ω 1/2W C.R.
jR113	46013400	33Ω 1/2W C.R.
jR114	46013400	33Ω 1/2W C.R.
jR116	46568100	100Ω 1/2W C.R.
jR117	46568300	120Ω 1/2W C.R.
jR118	46575300	100kΩ 1/2W C.R.
jR119	46572500	6.8kΩ 1/2W C.R.
jR120	46572500	6.8kΩ 1/2W C.R.
jR121	46572500	6.8kΩ 1/2W C.R.
jR122	46572500	6.8kΩ 1/2W C.R.
jC3	48061200	1000pF 125V P.C.
jC4	46419700	2700pF 125V P.C.
jC5	46628500	470μF 50V E.C.
jC6	48061200	1000pF 125V P.C.
jC7	48061200	1000pF 125V P.C.
jC10	46419700	2700pF 125V P.C.
jC11	46540300	470μF 50V E.C.
jC12	46540300	470μF 50V E.C.
jC13	46419700	2700pF 125V P.C.
jC14	46420400	0.01μF 125V P.C.
jC15	46419700	2700pF 125V P.C.
jC16	46419700	2700pF 125V P.C.
jC21	46946600	68000pF 125V P.C.
jC22	46946600	68000pF 125V P.C.
jC23	48004400	1000μF 50V E.C.
jC24	48004400	1000μF 50V E.C.
jC25	48004400	1000μF 50V E.C.
jC26	48004400	1000μF 50V E.C.
jC33	46419700	2700pF 125V P.C.
jC34	46628500	470μF 50V E.C.
jC36	46420400	0.01μF 125V P.C.
jC41	46419700	2700pF 125V P.C.
jC42	46540300	470μF 50V E.C.
jC43	46540300	470μF 50V E.C.
jC44	46419700	2700pF 125V P.C.
jC45	46420400	0.01μF 125V P.C.
jC46	46419700	2700pF 125V P.C.
jC47	46419700	2700pF 125V P.C.
jC49	46420400	0.01μF 125V P.C.
jC50	46420400	0.01μF 125V P.C.
jC51	46628100	100μF 50V E.C.
jC52	46628100	100μF 50V E.C.
jVR1	10342500	4.7kΩ(B) S.V.R., DC OV Adj.
jVR2	10342500	4.7kΩ(B) S.V.R., DC OV Adj.
IRL2	48004500	Relay, Protector

2-15. F-4484RECインジケータースイッチ基板

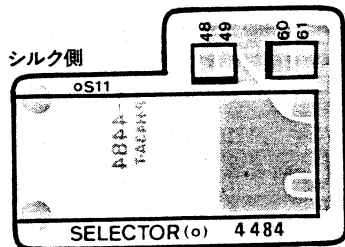

部品表

Parts No.	Stock No.	Description
oS11	48005300	Rotary SW., REC SELECTOR

2-16. F-4571RECインジケータースランプ基板

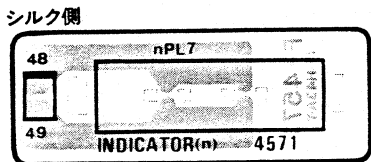

部品表

Parts No.	Stock No.	Description
nPL7	48054100	8V 0.1A Pilot Lamp, REC SELECTOR

2-19. F-4585VOLUMEインジケータースランプ基板

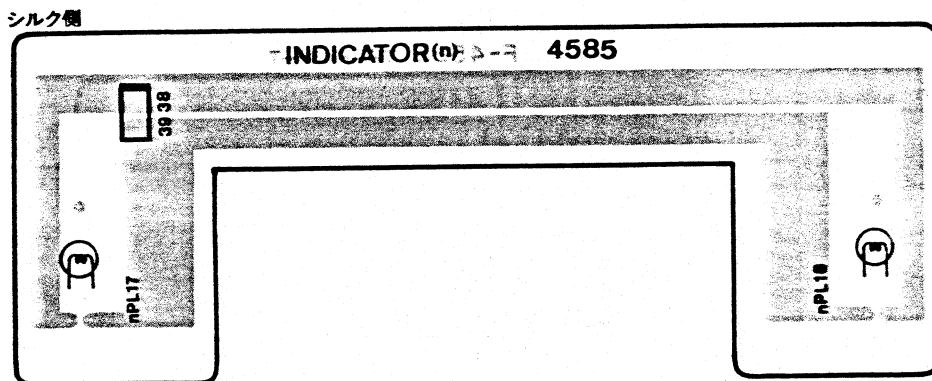

部品表

Parts No.	Stock No.	Description
nPL17	48049600	8V 0.1A Pilot Lamp, VOLUME
nPL18	48049600	8V 0.1A Pilot Lamp, VOLUME

2-17. F-4572インジケータースランプ基板

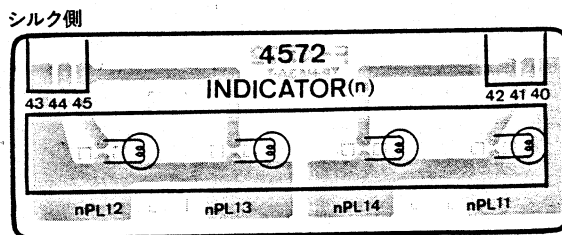

部品表

Parts No.	Stock No.	Description
nPL11	46730100	8V 0.1A Pilot Lamp, ADAPTOR
nPL12	48049600	8V 0.1A Pilot Lamp, MUTING
nPL13	48049600	8V 0.1A Pilot Lamp, SOURCE DIRECT
nPL14	48049600	8V 0.1A Pilot Lamp, SUBSONIC

2-18. F-4573パワーアンプインジケータースランプ基板

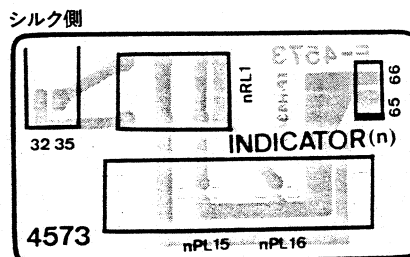

部品表

Parts No.	Stock No.	Description
nPL15	48054100	8V 0.1A Pilot Lamp, Protector
nPL16	46730100	8V 0.1A Pilot Lamp, Power
nRL1	48057000	Relay, Protector

4. 基板外部品表

4-1. 前面部

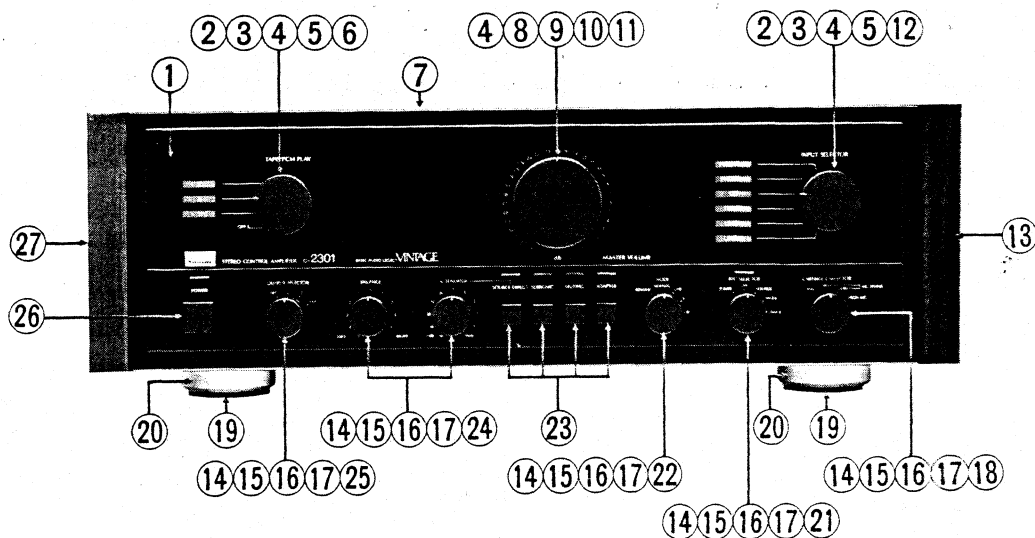

部品表

Parts No.	Stock No.	Description
1	47579800	Front Panel Ass'y
2	47576400	Knob, TAPE/PCM PLAY, INPUT SELECTOR
3	47577000	30φ Teflon Washer
4	47574500	24φ Shaft Ring
5	47576100	32φ Knob Base
6	48005400	Rotary SW., TAPE/PCM PLAY
7	47579500	Bonnet Ass'y
8	47576500	Knob, MASTER VOLUME
9	47577100	46φ Teflon Washer
10	47576300	48φ Knob Base
11	48004900	100kΩ V.R., MASTER VOLUME
12	48005500	Rotary SW., INPUT SELECTOR
13	47579700	Side Panel (Right)
14	47576600	Knob, CARTRIDGE SELECTOR, REC SELECTOR, MODE, ATTENUATOR, BALANCE, OUTPUT SELECTOR

Parts No.	Stock No.	Description
15	47576900	19φ Teflon Washer
16	47576700	8φ Shaft Ring
17	47576200	21φ Knob Base
18	48005200	Rotary Flex, CARTRIDGE SELECTOR
19	47120500	Leg Bushing
20	47120600	Leg
21	48005300	Rotary SW., REC SELECTOR
22	48004700	Rotary SW., MODE
23	48005000	Push SW., ADAPTOR, MUTING, SUBSONIC, SOURCE DIRECT
24	48004800	Rotary SW., ATTENUATOR, BALANCE
25	48004600	Rotary SW., OUTPUT SELECTOR
△ 26	46612900	Push SW., POWER
27	47579600	Side Panel (Left)

4-2. 背面部

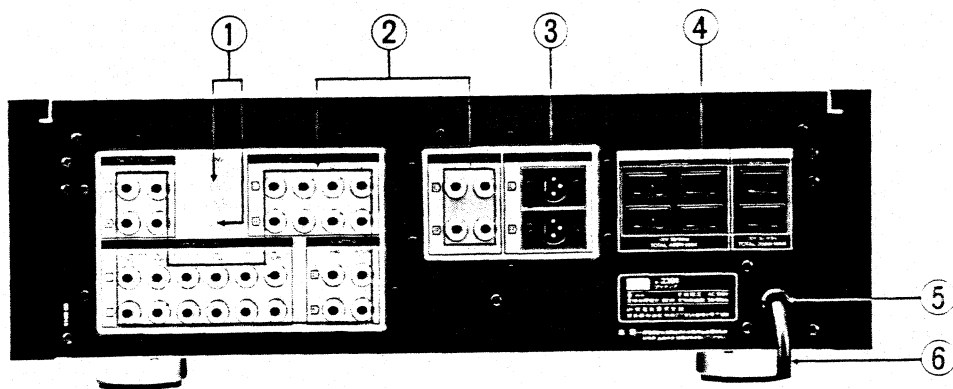

部品表

Parts No.	Stock No.	Description
1	48005700	Ground Terminal
2	48004100	1P Input Terminal
3	46580300	Canon Connector
△ 4	48004200	AC Outlet
5	39108600	Strain Relief
△ 6	46420700	Power Supply Cord

4-3. 上面部

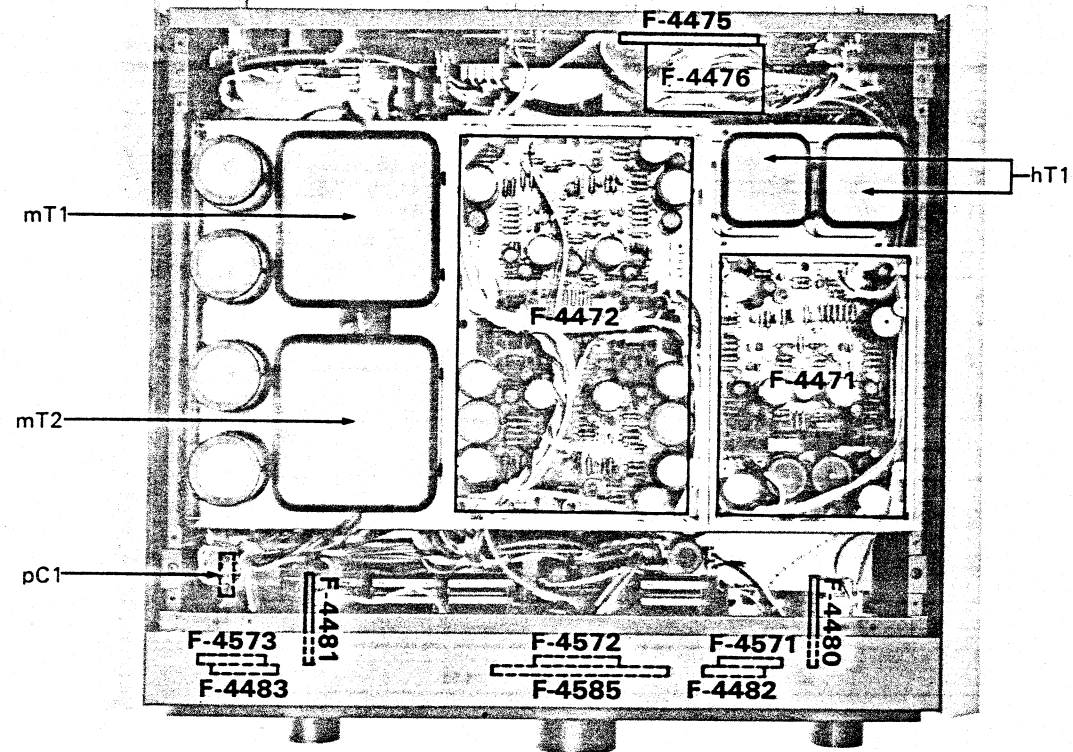

部品表

Parts No.	Stock No.	Description
hT1	48003900	MC Transformer
△ mT1	15016400	Power Transformer
△ mT2	15016500	Power Transformer
△ pC1	46946700	0.1μF 125V F.C.

4-4. 底面部

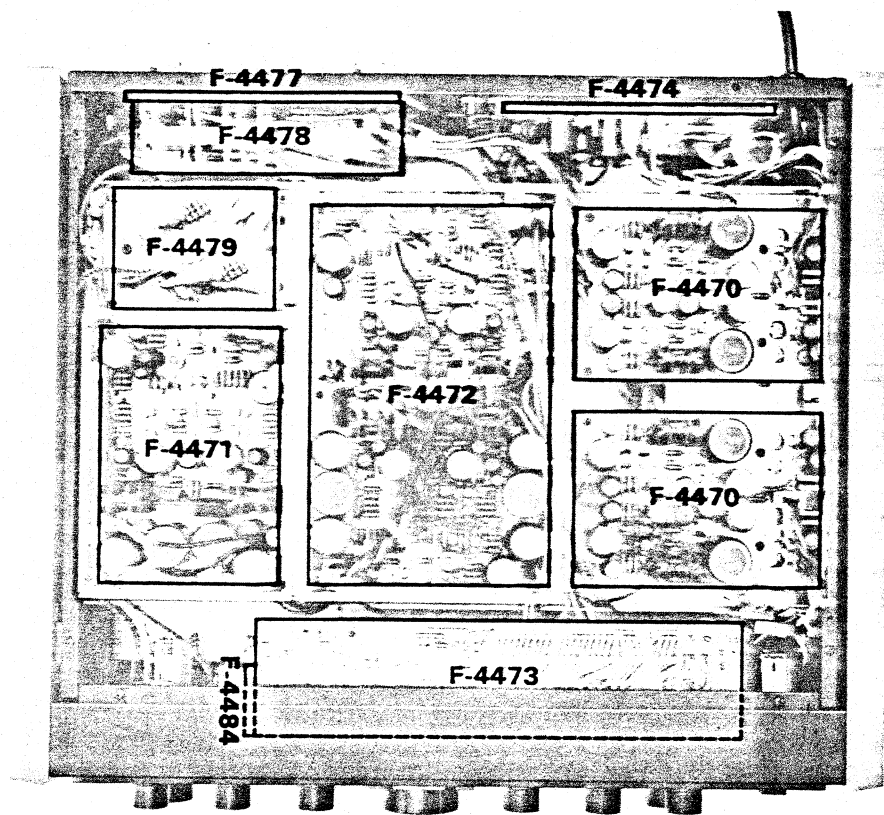

5. MCトランス配線図

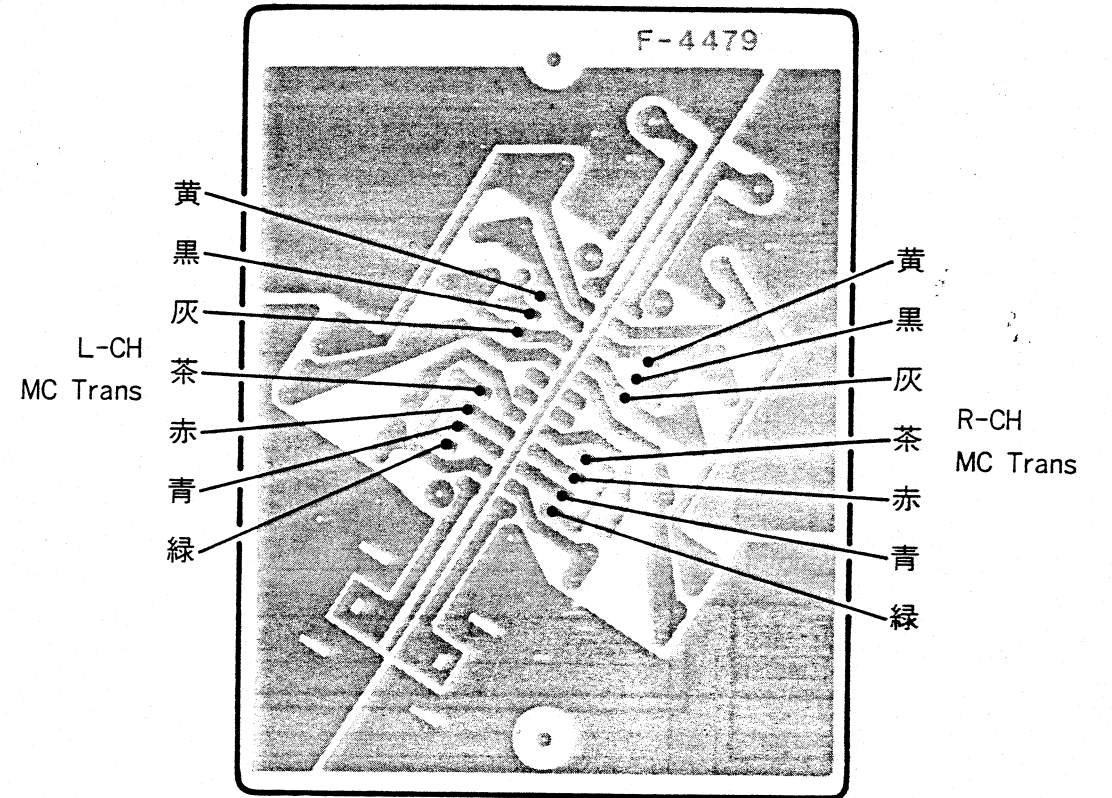

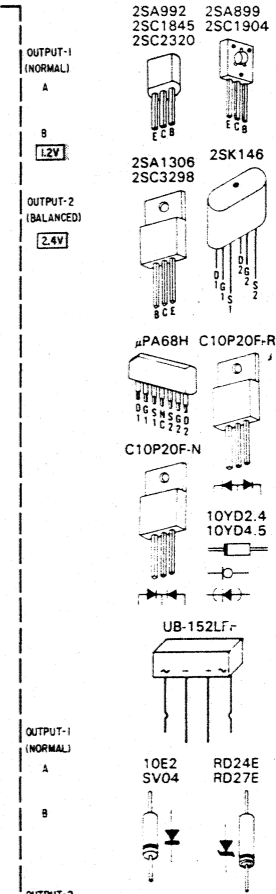
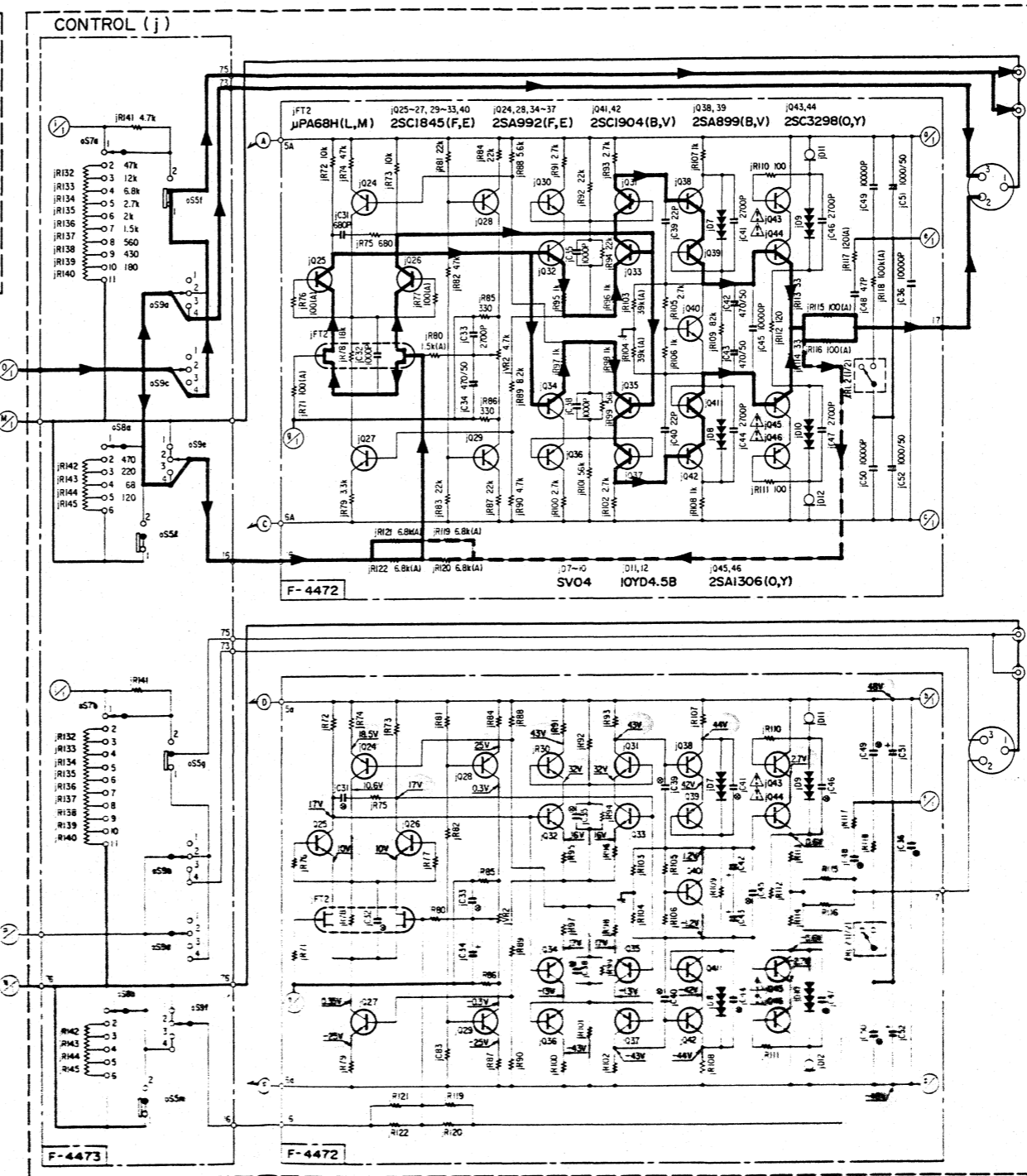
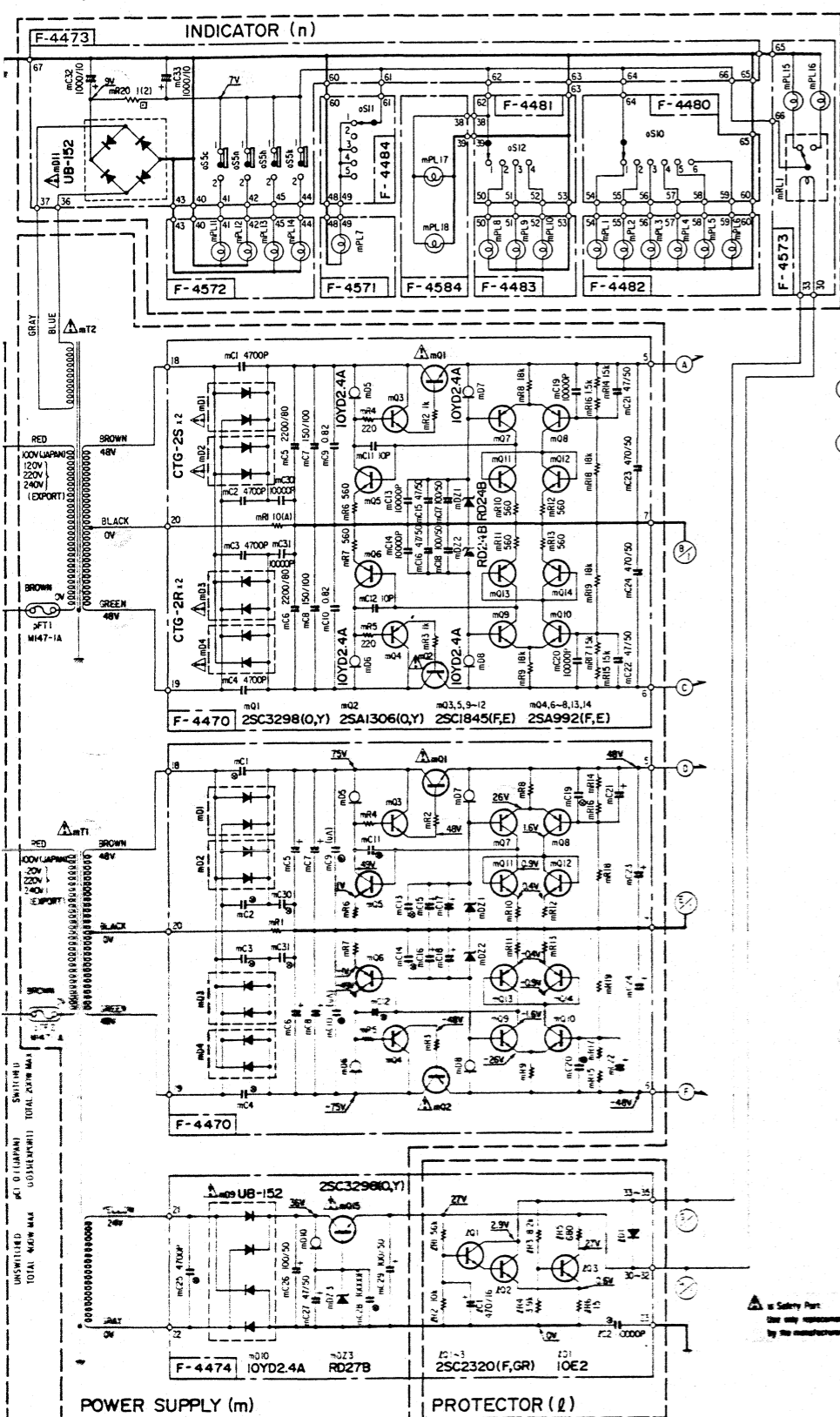

SYMBOL OF FUNCTION
 (j) CONTROL
 (l) PROTECTOR
 (m) POWER SUPPLY
 (n) INDICATOR
 (o) SELECTOR
 (p) FIXED PARTS

— Signal Line
 - - - N.F.B. Line

1
2
3
4
5

6

7. 梱包図と部品表

Parts No.	Stock No.	Description
1	47576800	Vinyl Bag
2	47580600	Packing
3	47577400	Carton Case

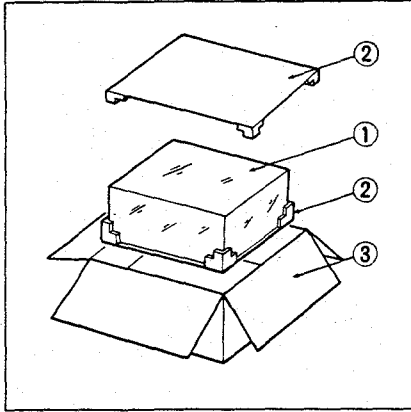

8. 付属部品表

Stock No.	Description
24105600	Short Pin Plug
48057500	PJP Cord (Red)
48057600	PJP Cord (White)
46956800	Operating Instruction